

CALDERA 4246 PENDANT

PROJECT PROJÉT
SPEC TYPE
NOTES



FINISH FINI



BLKE

WHE

FAMILY FAMILLE

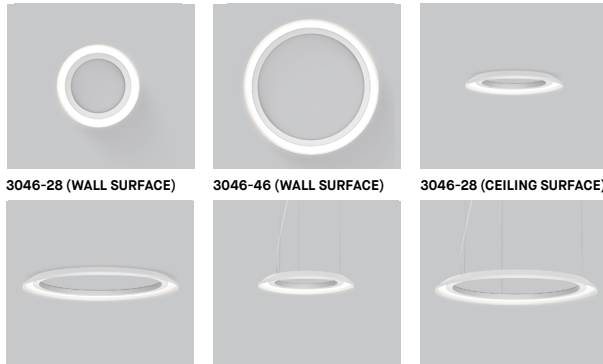

3046-28 (WALL SURFACE)

3046-46 (WALL SURFACE)

3046-28 (CEILING SURFACE)

3046-46 (CEILING SURFACE)

4246-28

4246-46

MOUNTING MONTAGE

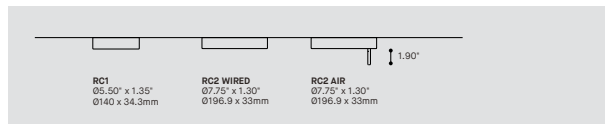

MOUNTING CABLE OPTION OPTION DE MONTAGE CÂBLE

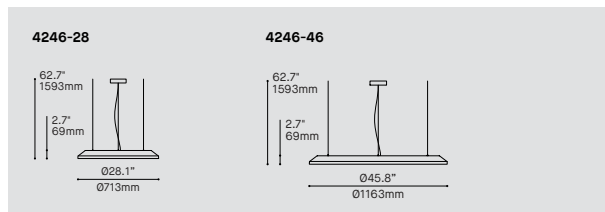
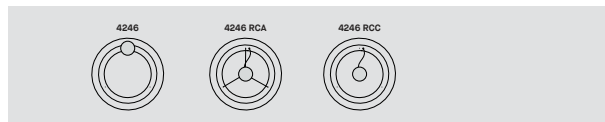

ORDERING SPECIFICATION	SPÉCIFICATION DE COMMANDE	CODE
MODEL MODÈLE		
4246-28	CALDERA 28"	
4246-46	CALDERA 46"	
LIGHT SOURCE SOURCE LUMINEUSE		
LED	REGULAR OUTPUT	
LED.HO	HIGH OUTPUT	
LED.SHO*	SUPER HIGH OUTPUT	
* ONLY FOR 4246-28		
COLOR TEMPERATURE TEMPÉRATURE DE COULEUR		
27	2700K	
30	3000K	
35	3500K	
40*	4000K	
* LONGER LEAD TIME MAY APPLY. PLEASE CONTACT YOUR EUREKA REPRESENTATIVE		
COLOR RENDERING INDEX (CRI) INDICE DE RENDU DE COULEUR (IRC)		90
90	90+ CRI	
VOLTAGE VOLTAGE		
120V	120 VOLT	
277V	277 VOLT	
CONTROL OPTION OPTION DE CONTRÔLE		
DV	0-10V DIMMING (120V-277V)	
DP	PHASE DIMMING (120V ONLY)	
NLTAIR2*	NLIGHT AIR CONTROL GEN 2	
NLIGHT*	NLIGHT WIRED CONTROL	
* REQUIRES RC2 CANOPY		
* EMERGENCY BATTERY NOT AVAILABLE WITH NLIGHT OPTIONS		
REFER TO NLIGHT GUIDE AND INSTALLATION SHEET FOR ALL REQUIREMENTS		
EMERGENCY BATTERY BATTERIE D'URGENCE		
EM DRIVER BOX INCLUDED, INSTALLED REMOTELY. SEE EM GUIDE FOR DETAILS.		
EMB*	EMERGENCY BATTERY FOR REMOTE BOX	
* 3981E ACCESSORY IS REQUIRED FOR THIS OPTION		
CABLE CÂBLE		AC
AC	AIRCRAFT MOUNTING AND BLACK OR WHITE CABLE, FIELD ADJUSTABLE	
CABLE LENGTH LONGUEUR DE CÂBLE		
60	60" AIRCRAFT CABLE (STD LENGTH)	
**	CUSTOM AIRCRAFT CABLE LENGTH (PLEASE SPECIFY)	
FOR OVERALL LENGTH PLEASE CONTACT YOUR EUREKA REPRESENTATIVE		
MOUNTING MONTAGE		
RC1	SCREWLESS CANOPY Ø5.50" X 1.35" (2473F)	
RC2	NLIGHT SCREWLESS CANOPY Ø7.75" X 1.30" (2474H)	
MOUNTING CABLE OPTION OPTION DE MONTAGE DE CÂBLE		
RCA	CENTERED ROUND CANOPY – AIRCRAFT CABLES ANGLED TO CENTER	
RCC	CENTERED ROUND CANOPY – STRAIGHT AIRCRAFT CABLES	
IF NO OPTION IS SELECTED, AN OFF-CENTERED ROUND CANOPY WITH STRAIGHT AIRCRAFT CABLES IS STANDARD		
CANOPY FINISH FINI PAVILLON		
BLKE	BLACK FINE TEXTURE	
WHE	WHITE FINE TEXTURE	
POWER CORD FINISH FINI CÂBLE D'ALIMENTATION		
BLK	BLACK POWER CORD	
WH	WHITE POWER CORD	
EXTERIOR SHADE FINISH FINI ABAT-JOUR EXTÉRIEUR (A)		
BLKE	BLACK FINE TEXTURE	
WHE	WHITE FINE TEXTURE	
RAL*	PLEASE SPECIFY RAL CODE	
* LONGER LEAD TIME MAY APPLY. PLEASE CONTACT YOUR EUREKA REPRESENTATIVE		
(A) SHADE INTERIOR IS ALWAYS WHITE		
ACCESSORY EMERGENCY BATTERY ACCESSOIRE BATTERIE D'URGENCE		
3981EA	ELECTRICAL BOX FOR EMB EMERGENCY BATTERY	

PRODUCT CHARACTERISTICS CARACTÉRISTIQUES DU PRODUIT



SPECIFICATION

CALDERA 4246 PENDANT TUNABLE WHITE

PROJECT PROJÉT
SPEC TYPE
NOTES



FINISH FINI



BLKE

WHE

FAMILY FAMILLE

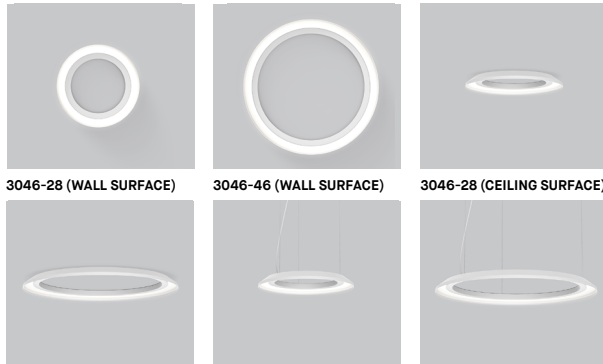

3046-28 (WALL SURFACE)

3046-46 (WALL SURFACE)

3046-28 (CEILING SURFACE)

3046-46 (CEILING SURFACE)

4246-28

4246-46

MOUNTING MONTAGE



MOUNTING CABLE OPTION OPTION DE MONTAGE CÂBLE



4246-28

4246-46

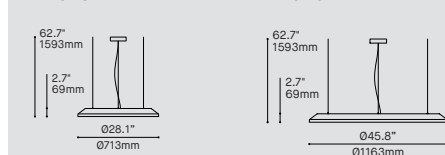

ORDERING SPECIFICATION	SPÉCIFICATION DE COMMANDE	CODE
MODEL MODÈLE		
4246-28	CALDERA 28"	
4246-46	CALDERA 46"	
LIGHT SOURCE SOURCE LUMINEUSE		LED
LED	REGULAR OUTPUT	
COLOR TEMPERATURE TEMPÉRATURE DE COULEUR		TW
TW*	TUNABLE WHITE (2700K TO 5000K) * LONGER LEAD TIME MAY APPLY. PLEASE CONTACT YOUR EUREKA REPRESENTATIVE	
COLOR RENDERING INDEX (CRI) INDICE DE RENDU DE COULEUR (IRC)		80
80	80+ CRI	
VOLTAGE VOLTAGE		
120V	120 VOLT	
277V	277 VOLT	
CONTROL OPTION OPTION DE CONTRÔLE		
DDV	DUAL 0-10V DIMMING	
NLT	NLIGHT NTUNE CONTROL	
CABLE CÂBLE		AC
AC	AIRCRAFT MOUNTING AND BLACK OR WHITE CABLE, FIELD ADJUSTABLE	
CABLE LENGTH LONGUEUR DE CÂBLE		
60	60" AIRCRAFT CABLE (STD LENGTH)	
**	CUSTOM AIRCRAFT CABLE LENGTH (PLEASE SPECIFY) FOR OVERALL LENGTH PLEASE CONTACT YOUR EUREKA REPRESENTATIVE	
MOUNTING MONTAGE		RC
RC	SCREWLESS CANOPY Ø9.42" X 1.88" (2475i)	
MOUNTING CABLE OPTION OPTION DE MONTAGE DE CÂBLE		
RCA	CENTERED ROUND CANOPY – AIRCRAFT CABLES ANGLED TO CENTER	
RCC	CENTERED ROUND CANOPY – STRAIGHT AIRCRAFT CABLES IF NO OPTION IS SELECTED, AN OFF-CENTERED ROUND CANOPY WITH STRAIGHT AIRCRAFT CABLES IS STANDARD	
CANOPY FINISH FINI PAVILLON		
BLKE	BLACK FINE TEXTURE	
WHE	WHITE FINE TEXTURE	
POWER CORD FINISH FINI CÂBLE D'ALIMENTATION		
BLK	BLACK POWER CORD	
WH	WHITE POWER CORD	
EXTERIOR SHADE FINISH FINI ABAT-JOUR EXTÉRIEUR (A)		
BLKE	BLACK FINE TEXTURE	
WHE	WHITE FINE TEXTURE	
RAL*	PLEASE SPECIFY RAL CODE * LONGER LEAD TIME MAY APPLY. PLEASE CONTACT YOUR EUREKA REPRESENTATIVE (A) SHADE INTERIOR IS ALWAYS WHITE	

PRODUCT CHARACTERISTICS CARACTÉRISTIQUES DU PRODUIT



DESIGN:

A sleek and narrow profile with a large hollow center allows Caldera to harmonize gracefully with its surroundings, while its sharper and refined silhouette adds an elegant aesthetic touch to any space.

INSTALLATION:

The triple aircraft mounting allows an easy installation, adjustability, and levelling.

LIGHT SOURCE:

An enveloping halo of light with minimal glare emerges from the invisible light source, hidden within the central ring. Offered with phase, 0-10V dimming, as well as nLight integrated system. Emergency option also available.

SHADE:

An aluminium construction coated with a high-quality fine texture paint.

CONCEPTION:

Un profil étroit et épuré ainsi qu'un centre ouvert permettent à Caldera de s'harmoniser avec grâce à son environnement, alors que sa silhouette angulaire et raffinée ajoute une touche visuelle élégante à tout espace.

INSTALLATION:

Câbles de retenue en acier facilitant l'installation, l'ajustement et la mise à niveau.

SOURCE LUMINEUSE:

halo de lumière enveloppant et sans éblouissement émerge d'une source lumineuse dissimulée dans l'anneau central. Offert avec gradation de type phase ou 0-10V, ainsi que nLight. Batterie d'urgence disponible.

ABAT-JOUR:

Construction en aluminium, recouverte d'une peinture finement texturée de haute qualité.

CALDERA 3046 / 4246

CANOPY POSITION

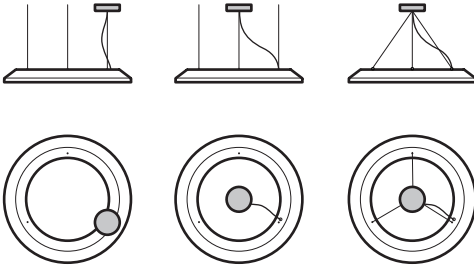

4246-XX
Canopy on mounting point (STD)

4246-XX RCC
Canopy centered with luminaire

4246-XX RCA
Canopy centered with luminaire

WEIGHTLESS FORM

With its thin profile and hollowed center, allowing you to see through the fixture's core, Caldera seems to float in space.

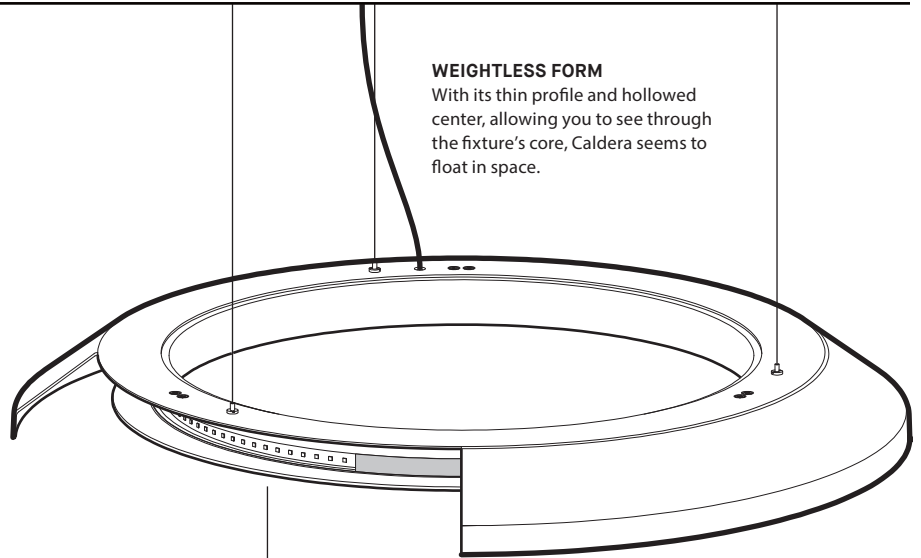

DISCREET ILLUMINATION

A thin lens wrapped around the LEDs helps create a softer illumination while retaining a high efficiency. The light source, hidden within the ring's cavity, is invisible from every angle allowing a minimal glare experience.

The conical shaped shade redirects light downwards to create an ambient illumination. Offered in two different diameters: 28" & 46".

MINIMAL SURFACE MOUNTING

With a depth of 2.7", Caldera is ADA compliant when installed on a wall.

Remote junction box(es) are provided with every surface mounted fixture.

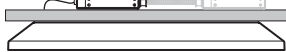

ADAPTABLE

Caldera is available in 2 surface mount options: installed on a rectangular cutout with no visible hardware or on an existing 4" hole with a cover plate (provided).

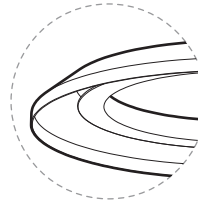

RECTANGULAR CUTOUT
Seamless, new installation



STANDARD 4" HOLE
Discreet plate, retrofit installation

PRODUCT SPECIFICATION

XX46-28

XX46-46

PERFORMANCE	REG	HO	SHO	TW REG	TW HO	REG	HO	TW REG
SYSTEM WATTAGE	25.0 W	52.5 W	82.0 W	25.0 W	52.3 W	49.9 W	104.9 W	50.0 W
DELIVERED LUMENS (4000K)	1724.8 LM	3198.8 LM	4510 LM	1531.2 LM	2750 LM	3366 LM	6072 LM	2926 LM
EFFICACY	69 LM/W	61 LM/W	55 LM/W	61 LM/W	52 LM/W	67 LM/W	58 LM/W	58 LM/W
OTHER INFORMATION								
LUMINAIRE'S WEIGHT	10 LBS / 4.5 KG					16 LBS / 7.2KG		
L70 (LUMEN MAINTENANCE) REG/HO/SHO	60,000 HRS					60,000 HRS		
MAX. LUMINANCE OF NADIR	3316 CD/M ²					1782 CD/M ²		
LIGHT QUALITY	R9 > 50							

EFFICACY MULTIPLIERS

CRI	CCT	FACTOR	TW FACTOR
80+	5000K	-	0.93
80+	4000K	-	1.00
80+	3500K	-	0.99
80+	3000K	-	0.98
80+	2700K	-	0.91
90+	4000K	1.00	-
90+	3500K	0.96	-
90+	3000K	0.92	-
90+	2700K	0.87	-

LIGHT DISTRIBUTION

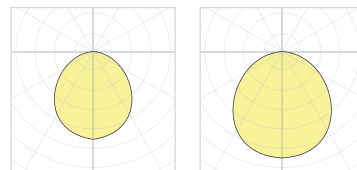

XX46-28

XX46-46



Visit our website for warranty terms and conditions.



TECHNICAL DATA

CALDERA 3046 / 4246

POSITION PAVILLON

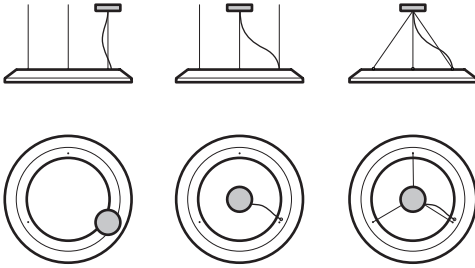

4246-XX
Pavillon au point de montage (STD)

4246-XX RCC
Pavillon au centre du luminaire

4246-XX RCA
Pavillon au centre du luminaire

FORME DÉLICATE

Avec son profil mince et centre vide, vous permettant de voir au travers du luminaire, Caldera semble flotter dans l'espace.

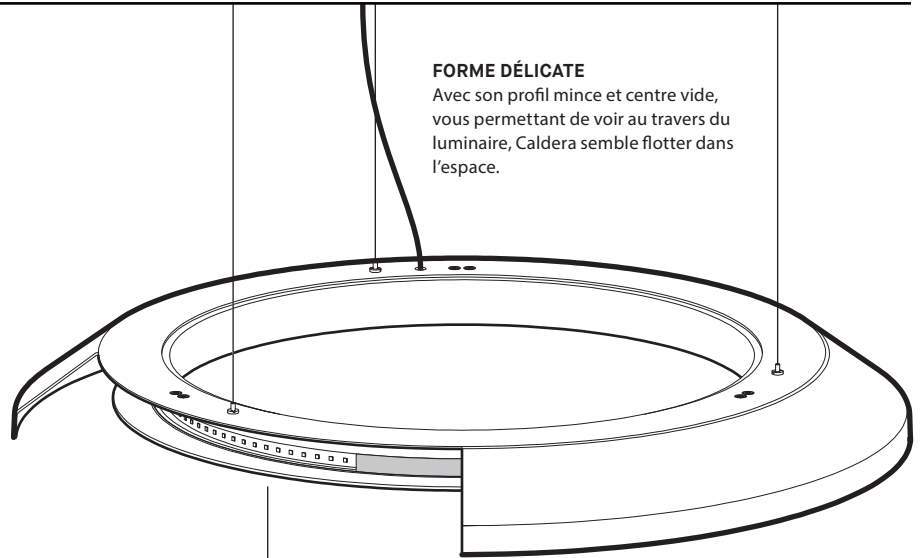

ILLUMINATION DISCRÈTE

Une lentille mince enveloppée autour des LEDs aide à produire une lumière plus douce en retenant une haute efficacité. La source lumineuse, cachée à l'intérieur de l'anneau, est invisible de tous les angles, permettant une vue avec peu d'éblouissement.

L'abat-jour de forme conique redirige la lumière vers le bas pour créer un éclairage ambiant. Offert en deux diamètres: 28" & 46".



MONTAGE SURFACE MINIMALE

Avec une profondeur de 2.7", Caldera est conforme à la norme ADA lorsqu'installé au mur.

Boîte(s) de jonction remote sont fourni avec toutes fixatures surface.

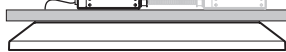

ADAPTABLE

offert avec 2 options de montage surface: installé sur une découpe rectangulaire avec aucune quincaillerie visible ou sur un trou de 4" existant avec une plaque (fourni).

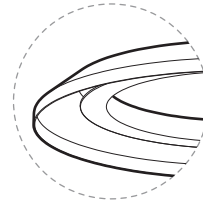

DÉCOUPE RECTANGULAIRE
Uniforme, nouvelle installation



TROU STANDARD 4"
Plaque discrète, installation réaménagée

SPÉCIFICATION PRODUIT

XX46-28

XX46-46

PERFORMANCE	REG	HO	SHO	TW REG	TW HO	REG	HO	TW REG
PUISSANCE TOTALE	25,0 W	52,5 W	82,0 W	25,0 W	52,3 W	49,9 W	104,9 W	50,0 W
LUMENS RÉELS (4000K)	1724,8 LM	3198,8 LM	4510 LM	1531,2 LM	2750 LM	3366 LM	6072 LM	2926 LM
EFFICACITÉ	69 LM/W	61 LM/W	55 LM/W	69 LM/W	60 LM/W	76 LM/W	66 LM/W	66 LM/W

AUTRES INFORMATION

POIDS PAR TÊTE 10 LBS / 4.5KG
L70 (MAINTENANCE DE LA LUMIÈRE) REG/HO/SHO 60,000 HRS
MAX. LUMINANCE NADIR 3316 CD/M²
QUALITÉ DE LA LUMIÈRE R9 > 50

16LBS / 7.2KG
 60,000 HRS
 1782 CD/M²

FACTEURS D'EFFICACITÉ

CRI	CCT	FACTEUR	FACTEUR TW
80+	5000K	-	0.93
80+	4000K	-	1.00
80+	3500K	-	0.99
80+	3000K	-	0.98
80+	2700K	-	0.91
90+	4000K	1.00	-
90+	3500K	0.96	-
90+	3000K	0.92	-
90+	2700K	0.87	-

DISTRIBUTION LUMINEUSE

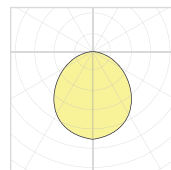

XX46-28

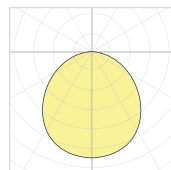

XX46-46



VisiteznotresiteWebpourlestermesetconditions.



DONNÉES TECHNIQUES

JUNCTION BOX 3981E

PROJECT PROJET
SPEC TYPE
NOTES



ORDERING SPECIFICATION SPÉCIFICATION DE COMMANDE

CODE

MODEL MODÈLE

3981EA	APPROX. 10W MAX EMERGENCY BACKUP POWER
3981EB	APPROX. 5W MAX EMERGENCY BACKUP POWER

PRODUCT CHARACTERISTICS CARACTÉRISTIQUES DU PRODUIT

DESIGN:	Remote junction box and cover with an emergency backup driver. Features matching wires and labelling to simplify installation. Is required to complete luminaires ordered with EMB remote emergency box option (selected models, refer to specification sheets. Other models possible upon request). Available in several power outputs, selected according to the luminaire power.
STRUCTURE:	Die-stamped 16 gauge grey painted steel. Knockouts on all 4 sides from 1/2" to 1-1/4".
CERTIFIED:	c-CSA-us, UL, RoHS, NEMA Type 1, FCC
CONCEPTION:	Boîte de jonction à distance avec couvercle avec batterie d'urgence intégré. Contient des fils avec couleurs et étiquetage pour simplifier l'installation. Requis pour compléter un luminaire commandée avec l'option EMB (voir pages de spécification pour produits avec l'option EMB. Autres produits possibles sur demande). Disponible en plusieurs puissances, sélectionnées en fonction du luminaire.
STRUCTURE:	Acier plié de 16 jauge peinturé gris avec coins soudés. Débouchures sur 4 côtés 1/2" à 1-1/4".
CERTIFIÉ:	c-CSA-us, UL, RoHS, NEMA Type 1, FCC

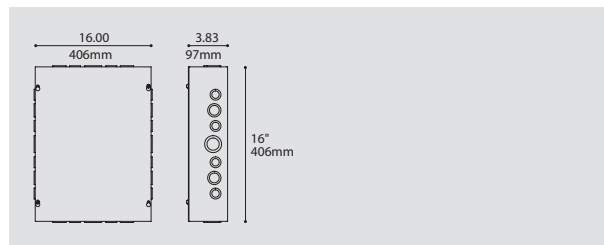

INSTALLATION SUMMARY SOMMAIRE D'INSTALLATION

STEP 1 ÉTAPE 1

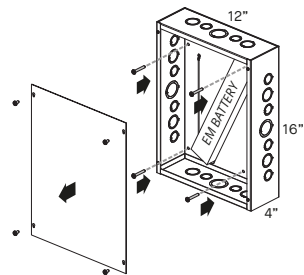

Remove cover and fasten box remotely to a wall or a ceiling.
Enlever le couvercle et fixer la boîte à distance sur un mur ou un plafond.

STEP 2 ÉTAPE 2

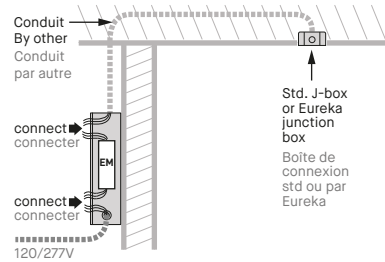

Run conduit from box to junction box of luminaire. Conduit must have a minimum of 5 wires with wire gauge and maximum distance as per EM driver distance chart. Connect EM driver to conduit wires and ac branch circuit. Faites passer le conduit de la boîte EM à la boîte de connexion du luminaire. Consulter le tableau de "distance maximale" disponible dans la feuille d'installation. Branchez la batterie EM avec les fils du conduit ainsi que la ligne 120V ou 277V.

STEP 3 ÉTAPE 3

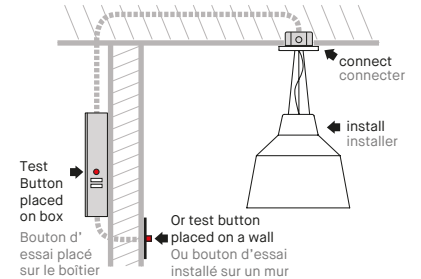

Install luminaire & connect its wires to conduit. Install test button on wall or box (wall plate not supplied). Installer le luminaire & connecter les fils au conduit. Installer le bouton d'essai sur le mur ou boîtier (plaque murale non fournie).

REFER ALSO TO INSTALLATION DRAWING AND EM GUIDE FOR MORE INFORMATION.
CONSULTEZ LE DESSIN D'INSTALLATION ET LE GUIDE EM POUR PLUS D'INFORMATIONS.



SPECIFICATION

3981E REMOTE EMERGENCY BOX KIT - IOTA EM DRIVER

SAFETY GUIDELINES :

- > Follow safety instructions and guidelines of EM battery/driver manufacturer for the specific model.
- > Install by qualified personnel in accordance with the National Electrical Code and local regulations.
- > Turn off power supply before installation or servicing the fixture.

EMB LOCATION :

- > The 3981E box connects to a luminaire ordered with an EMB option (which has specific EM WIRING).
- > Consult our chart for maximum remote distance of EM battery to luminaire leds.
- > Establish desired location for EMB box & EM test button on box or on a wall.

EM Remote Distance Chart
Maximum distance EM battery to Luminaire LEDs (Ft)

MAX EM BOX DISTANCE (Ft)	CONDUIT WIRE GAUGE (AWG)							
	10	12	14	16	18	20	22	
LUMINAIRE	200mA	1043'	651'	413'	259'	163'	103'	65'
DRIVER	350mA	596'	372'	236'	148'	93'	59'	37'
OUTPUT	500mA	417'	261'	165'	104'	65'	41'	26'
CURRENT*	700mA	298'	186'	118'	74'	47'	29'	18'
(Amps)	1000mA	209'	130'	83'	52'	33'	21'	13'
*Contact Eureka	1400mA	149'	93'	59'	37'	23'	15'	9'
	2000mA	104'	65'	41'	26'	16'	10'	6'
	3000mA	70'	43'	28'	17'	11'	7'	4'

EMB PLACEMENT EXAMPLES :

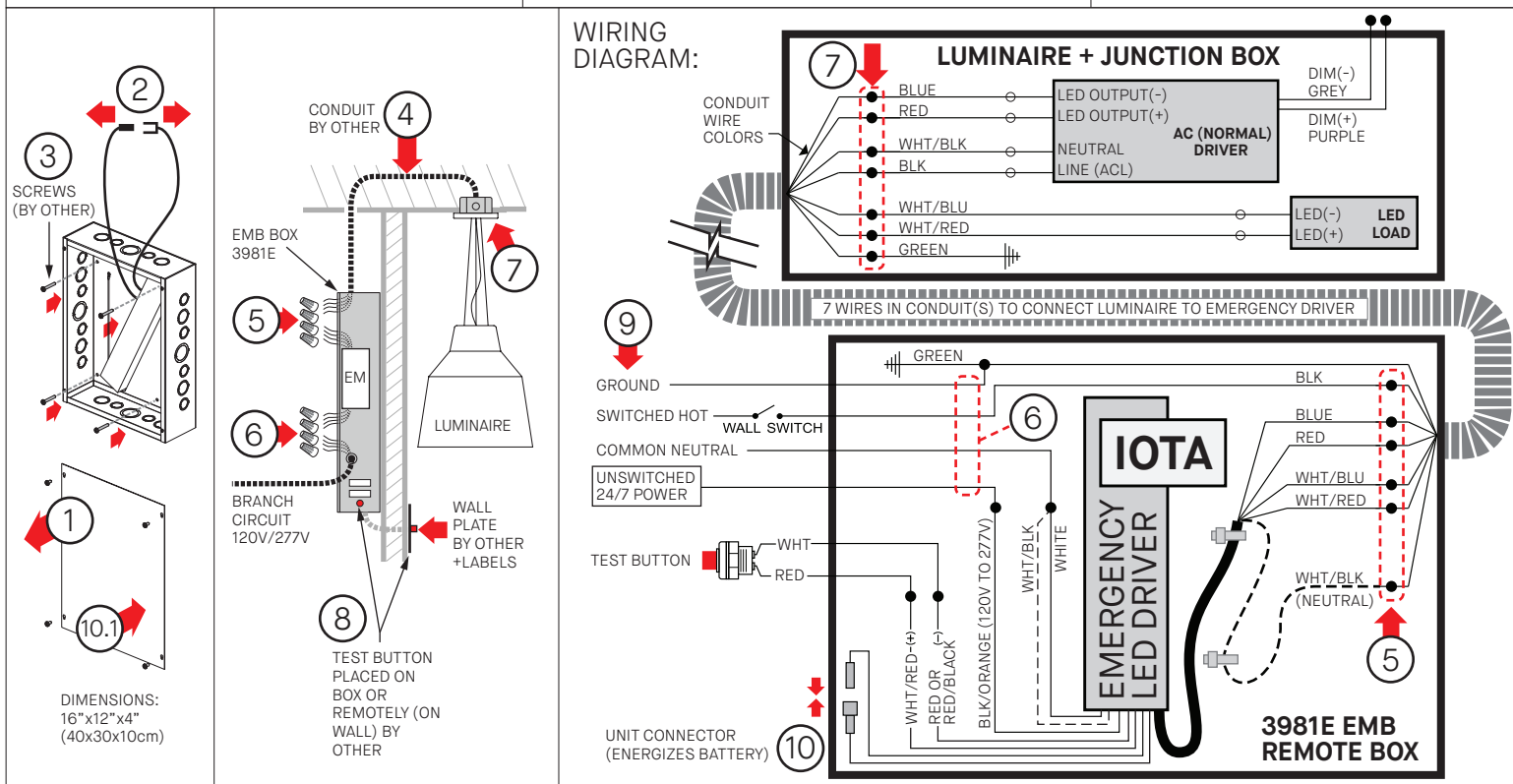
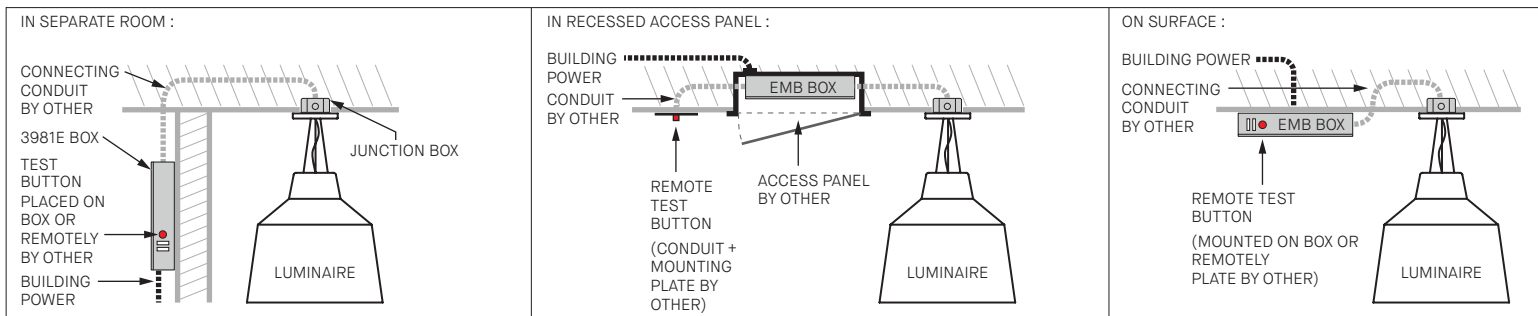

INSTALLATION

- 1 - REMOVE BOX COVER.
- 2 - IF CONNECTED, DISCONNECT THE EM BATTERY 'UNIT CONNECTOR' (WHITE).
- 3 - SCREW BOX TO MOUNTING SURFACE (SCREWS NOT SUPPLIED)
- 4 - RUN CONDUIT FROM EMB BOX TO ELECTRICAL JUNCTION BOX OF LUMINAIRE. CONDUIT MUST HAVE MIN. 7 WIRES AND WIRE GAUGE AS PER DISTANCE CHART.
- 5 - CONNECT CONDUIT WIRES TO EM BATTERY AS PER WIRING DIAGRAM.
CAREFULLY NOTE WHICH WIRE COLORS ARE CONNECTED TOGETHER ON EACH END.
- 6 - CONNECT BATTERY TO AC BRANCH CIRCUIT : GROUND, NEUTRAL, 24/7 UNSWITCHED LINE (HOT) AND SWITCHED LINE (ON SAME CIRCUIT AS LUMINAIRE ON/OFF CONTROL).
- 7 - INSTALL SPECIFIC EM LUMINAIRE, CONNECT WIRES TO CONDUIT USING THE SAME CORRESPONDING COLORS NOTED AT THE EM BATTERY-CONDUIT CONNECTION.
- 8 - INSTALL EM BATTERY TEST BUTTON IN DESIRED LOCATION. WALL PLATE BY OTHER. ADD LABELS "PUSH TO TEST" & CHARGING INDICATOR LIGHT".

- 9 - SWITCH ON AC POWER.
- 10 - JOIN THE EM BATTERY CONVERTOR CONNECTOR. 10.1 - INSTALL BOX COVER.
- 11 - IF EMB IS FAR FROM THE LUMINAIRE, IDENTIFY TO WHICH LUMINAIRE IT IS CONNECTED.

AT THIS POINT POWER SHOULD BE CONNECTED TO BOTH THE AC DRIVER AND THE EMERGENCY DRIVER & TEST/CHARGE LIGHT SHOULD ILLUMINATE, INDICATING BATTERY IS CHARGING.

TESTING & EM DRIVER/BATTERY MAINTENANCE:

CONDUCT A SHORT-TERM DISCHARGE TEST AFTER THE EMERGENCY DRIVER HAS BEEN CHARGED FOR MINIMUM ONE HOUR. CHARGE FOR 24 HOURS BEFORE CONDUCTING A LONG-TERM DISCHARGE TEST.

FOLLOW GUIDELINES FROM THE EM DRIVER/BATTERY MANUFACTURER INSTRUCTIONS FOR THE REQUIRED PERIODIC TESTING AND MAINTENANCE GUIDELINES.

3981E BOÎTE D'URGENCE À DISTANCE - DRIVER EM IOTA

DIRECTIVES DE SÉCURITÉ:

- > Suivre les consignes de sécurité et les directives d'installation du fabricant de la batterie d'urgence.
- > Installer par du personnel qualifié conformément au code électrique national et local.
- > Fermer l'alimentation avant l'installation ou l'entretien.

EMPLACEMENT :

- > Cette boîte 3981E se connecte à un luminaire commandé avec l'option EMB (qui a du filage spécifique).
- > Consulter le tableau pour la distance maximale de la batterie d'urgence aux DELs du luminaire.
- > Déterminer l'emplacement souhaité pour la boîte EMB et le bouton de test d'urgence.

EXEMPLES D'EMPLACEMENT:

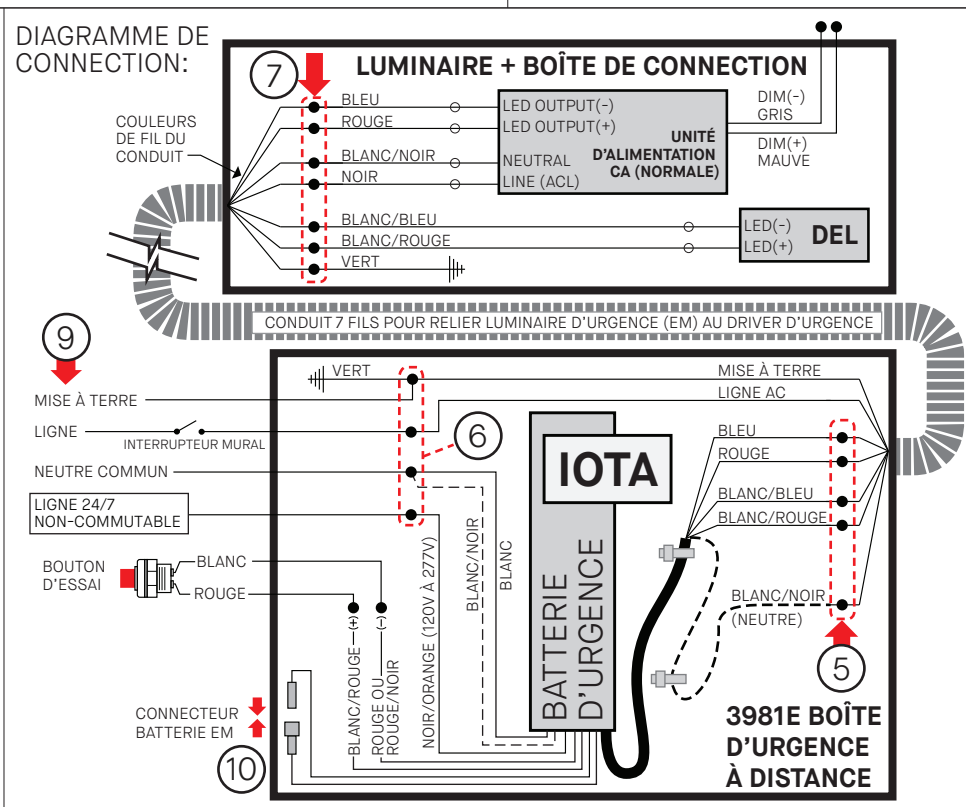
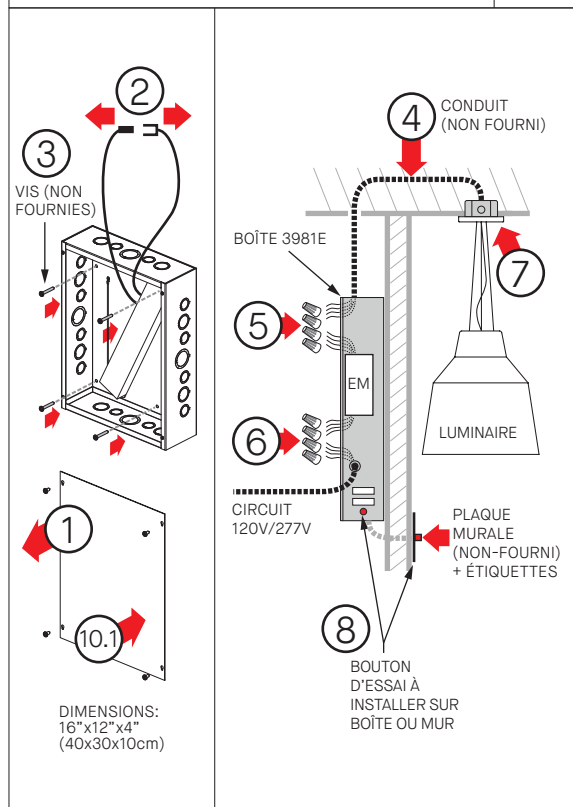
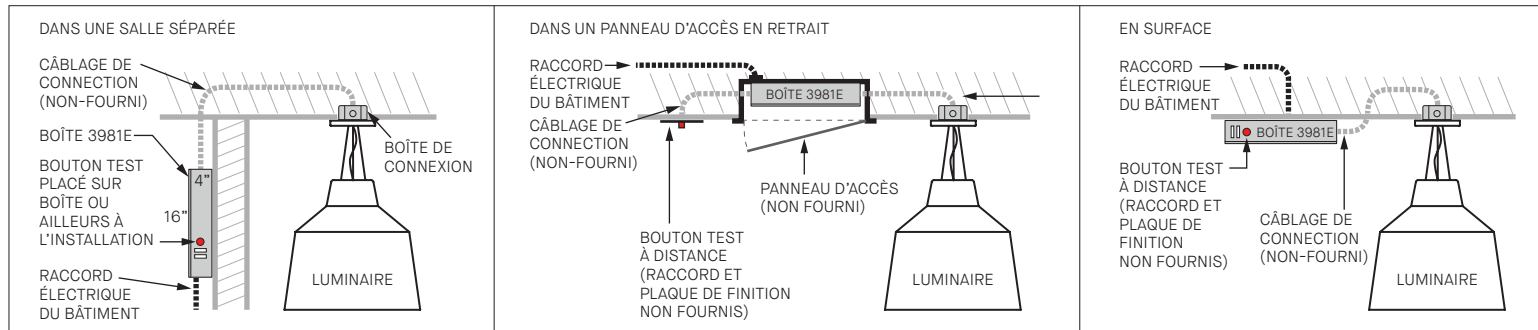

INSTALLATION

- 1 - DÉVISSER LE COUVERCLE.
- 2 - DÉCONNECTER LE CONNECTEUR BLANC DE BATTERIE EM (UNIT CONNECTOR).
- 3 - FIXER LA BOÎTE SUR LE MUR/PALAFOND AVEC VIS (NON FOURNIES)
- 4 - PASSER DU CONDUIT DU EMB VERS LA BOÎTE DE CONNEXION ÉLECTRIQUE DE LUMINAIRE. LE CONDUIT DOIT AVOIR 7 FILS AVEC GAUGE DE FIL SELON CHARTE DE DISTANCE.
- 5 - CONNECTER LES FILS DE CONDUIT À LA BATTERIE EM SELON LE SCHÉMA DE CÂBLAGE.
- 6 - CONNECTER LA BATTERIE AU CIRCUIT DE DÉRIVATION AC (FILS: MISE A LA TERRE, NEUTRE, LIGNE & LIGNE SANS INTERRUPTEUR 24H/7* (*DOIT ETRE LE MEME CIRCUIT QUE LE CONTROLE DU LUMINAIRE)).
- 7 - INSTALLER LUMINAIRE SPÉCIFIQUE EM, CONNECTER LES FILS AU CONDUIT AVEC MÊMES COULEURS CORRESPONDANTES DE LA BATTERIE EM AUX FILS DE CONDUIT.
- 8 - INSTALLEZ LE BOUTON D'ESSAI DE BATTERIE EM DANS L'ENDROIT SOUHAITÉ (PLAQUE MURALE PAR AUTRE). COLLER ÉTIQUETTES "PUSH TO TEST" & CHARGING INDICATOR LIGHT".

- 9 - ALIMENTER LE CIRCUIT AC.
- 10 - JOINDRE CONNECTEUR BLANC DE BATTERIE EM. 10.1 - INSTALLER COUVERCLE DE BOÎTE.
- 11 - SI LE EMB EST LOIN DU LUMINAIRE, IDENTIFIER À QUEL LUMINAIRE IL EST CONNECTÉ.

A CE STADE, L'ALIMENTATION DEVRAIT ÊTRE CONNECTÉE À L'UNITÉ D'ALIMENTATION AC ET LA BATTERIE D'URGENCE ET LA LUMIÈRE DE TEST/CHARGE S'ILLUMINE, INDIQUANT QUE LA BATTERIE SE CHARGE.

ESSAIS & ENTRETIEN DE LA BATTERIE:

FAITES UN TEST DE DÉCHARGE À COURT TERME APRÈS AVOIR CHARGÉ LA BATTERIE D'URGENCE AU MINIMUM UNE HEURE. CHARGEZ 24 HEURES AVANT D'EFFECTUER UN TEST DE DÉCHARGE À LONG TERME.

SUIVRE LES DIRECTIVES DU FABRICANT DE BATTERIE / CONDUCTEUR EM (SITE WEB) POUR LES DIRECTIVES PÉRIODIQUES REQUISES EN MATIÈRE DE TEST ET D'ENTRETIEN.

Charte de distance d'installation EM

Distance maximale entre Batterie d'urgence et DELs du luminaire (Pi)

DISTANCE MAX D'INSTALLATION (Pi)	GAUGE DE FILS DU CONDUIT (AWG)							
	10	12	14	16	18	20	22	
COURANT	200mA	1043'	651'	413'	259'	163'	103'	65'
ALIMENTATION DU LUMINAIRE*	350mA	596'	372'	236'	148'	93'	59'	37'
700mA	417'	261'	165'	104'	65'	41'	26'	
1000mA	298'	186'	118'	74'	47'	29'	18'	
*Contacter Eureka	1400mA	209'	130'	83'	52'	33'	21'	13'
	2000mA	149'	93'	59'	37'	23'	15'	9'
	3000mA	104'	65'	41'	26'	16'	10'	6'
		70'	43'	28'	17'	11'	7'	4'